



CATÁLOGO 2025
i l u m i n a c i ó n l e d

WINLED

artlite 

ar1lite



ASM-001



TIRA LED

24 WATTS

MÁX. 1300 LÚMENES

120° OMNIDIRECCIONAL



ATENUABLE

PROTECCIÓN IP65 EXTERIOR

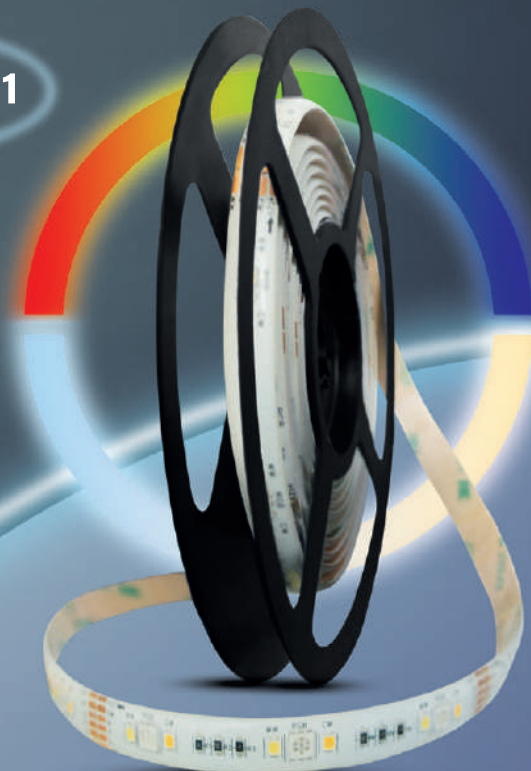

*Incluye 1 controlador y 1 driver.

TIRA LED SMART RGB CW COLORES Y BLANCOS DINAMICOS WIFI BLUETOOTH C/DRIVER 100-240V~50/60Hz CUBIERTA SILICÓN 5MTS



ALA-029



BULBO

10 WATTS

MÁX. 850 LÚMENES

180° OMNIDIRECCIONAL



ATENUABLE

E26 BASE

PROTECCIÓN IP20 INTERIOR

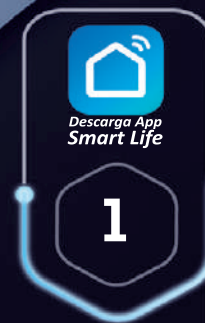

Descarga App Smart Life

1

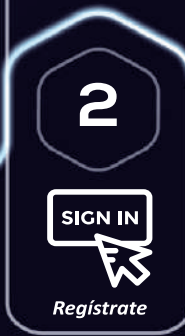

2

SIGN IN

Regístrate



*APP disponible para sistemas IOS y ANDROID.
 *Requiere conexión a internet mediante red Wi-Fi 2.4 GHz.
 *Compatible con comando de voz: Google Assistant y Amazon Alexa.

LÁMPARA LED SMART WIFI Y BLUETOOTH RGB CW MULTICOLOR Y BLANCOS ATENUABLES 110-130V~50/60Hz. PLÁSTICO 60x119 mm.

Conéctanos con:

 amazon alexa

 Google Assistant

ASM-002



ENCHUFE

MÁX.
1875
WATTS

PROTECCIÓN
IP20
INTERIOR



ENCHUFE SMART REDONDO WIFI BLUETOOTH
90-260V~50/60Hz POLICARBONATO
15A Corriente @125V~, D. 50.6 x 52 mm

ALA-030

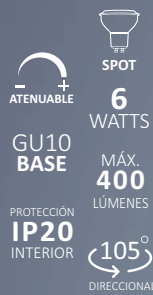

ATENUABLE

SPOT

6
WATTS

GU10
BASE

MÁX.
400
LÚMENES

PROTECCIÓN
IP20
INTERIOR

105°
DIRECCIONAL



LÁMPARA LED SMART WIFI Y BLUETOOTH
110-130V~50/60Hz RGB CW MULTICOLOR Y
BC ATENUABLES. BASE GU10 50x55 mm



Agrega los productos

3

4



Controla



Pánel LED Redondo Slim | EMPOTRABLE



Lamina + PC



90-277V~50/60Hz



IP20 (Interiores)



120° Apertura



Incluye Driver

3W



12W



24W



ADO-001



6500K

3W

250LM

D. 88x18mm/Emp. 7.3cm

ADO-009



3000K

3W

230LM

D. 88x18mm/Emp. 7.3cm

ADO-002



6500K

6W

500LM

D. 119x18mm/Emp. 10.3cm

ADO-010



3000K

6W

450LM

D. 119x18mm/Emp. 10.3cm

ADO-003



6500K

12W

1,000LM

D. 168x18mm/Emp. 15.5cm

ADO-008



3000K

12W

950LM

D. 168x18mm/Emp. 15.5cm

ADO-005



6500K

18W

1,500LM

D. 220x14mm/Emp. 20.5cm

ADO-011



3000K

18W

950LM

D. 220x14mm/Emp. 20.5cm

ADO-019



6500K

24W

2,000LM

D. 294x18mm/Emp. 28.5cm

ADO-020



3000K

24W

1,950LM

D. 294x18mm/Emp. 28.5cm

15W



Pánel LED Redondo SOBREPONER

ADO-018



1400LM



6500K



140 x 43 mm



100-277V~50/60Hz



IP65



A Prueba de VAPOR



Pánel LED Redondo / Cuadrado | **SOBREPONER**

- Lamina + PC
- 90-277V~50/60Hz
- IP20 (Interiores)
- 120° Apertura
- Incluye Driver



#	W		
ADO-015	6W	500LM	D. 112x28mm
ADO-016	6W	450LM	D. 112x28mm
ADO-004	12W	1,000LM	D. 161x28mm
ADO-012	12W	950LM	D. 161x28mm
ADO-013	18W	1,500LM	D. 210x28mm
ADO-014	18W	1,450LM	D. 210x28mm



Pánel LED Cuadrado

ADO-017 1800LM 6500K 282x282x43 mm 120°

90-277V~50/60Hz IP20 (Interiores)



Pánel LED Cuadrado *Slim*

ADO-006 2000LM 6500K 295X295x25 mm 120°

90-277V~50/60Hz IP20 (Interiores)



Pánel LED Cuadrado *Slim*

ADO-007 3400LM 6500K 595X595x30 mm 120°

90-277V~50/60Hz IP20 (Interiores)

Lámparas LED Filamento | VINTAGE



Lámpara LED Bulbo T *Ambar*

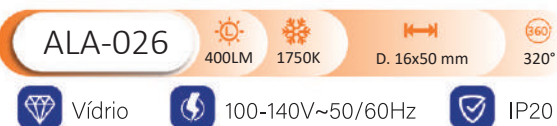

Lámpara LED Bulbo T *Ambar*



Lámpara Vela B35 Filamento



Lámpara LED G45 Filamento *Ambar*



Lámpara LED ST64 Filamento *Ambar*



Lámpara LED G45 Filamento *Ambar*



Lámparas LED | SPOT

- Plástico + Policarbonato
- IP20 (Interiores)
- 40° Apertura
- LED SMD 2835 Panasonic

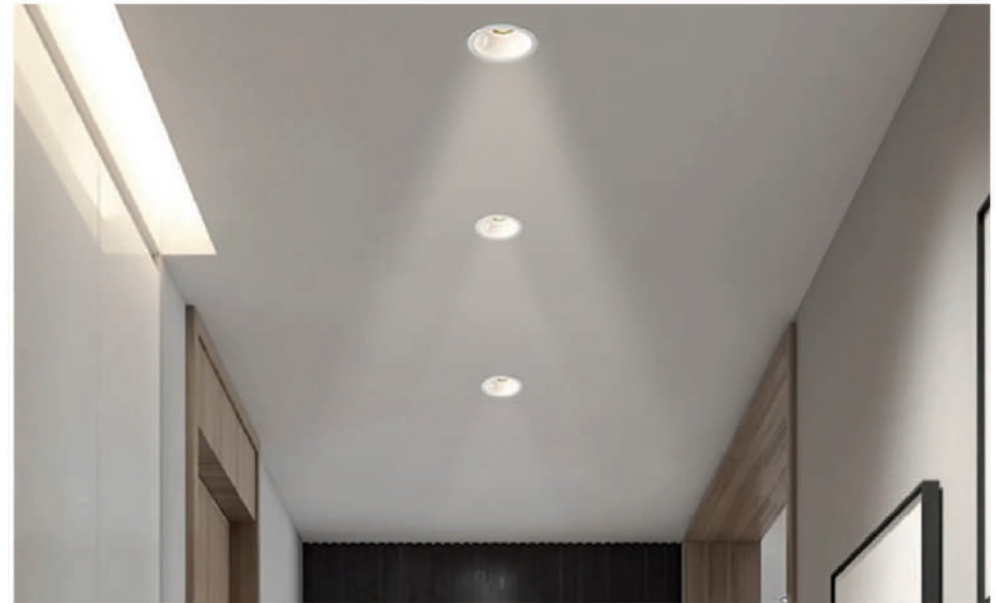

Lámpara LED Spot MR-16

- ALA-001 595LM 6500K 100-240V~50/60Hz
- ALA-002 550LM 3000K MR16



Lámpara LED Spot GU10

- ALA-006 595LM 6500K 100-140V~50/60Hz
- ALA-007 550LM 3000K GU10



Lámpara LED Spot MR-16

- ALA-014 595LM 6500K 100-140V~50/60Hz
- ALA-015 550LM 3000K MR16

Lámparas LED | BULBO

Plástico + Policarbonato

IP20 (Interiores)

220° Apertura

Base E26/E27



Lámpara LED Bulbo A70

ALA-017

1120LM 6500K



100-140V~50/60Hz



D. 60x110 mm



E26

ALA-018

1100LM 3000K



Lámpara LED Bulbo A70

ALA-032

1620LM 6500K



100-140V~50/60Hz



D. 70x136 mm



E26

ALA-033

1530LM 3000K

Lámparas LED | INDUSTRIAL



*Ejemplo de instalación punta poste

50W



Lámpara LED Punta Poste Arbotante E26

ALA-025 6500LM 6500K D. 138x190 mm 120°

ALA-024 6000LM 3000K D. 138x190 mm 120°

90-300V~50/60Hz Plástico + PC IP65 Exteriores

30W



Lámpara LED Industrial E26

ALA-019 3000LM 6500K D. 98x187 mm 120°

90-300V~50/60Hz Alum. + Plástico + Vidrio IP20

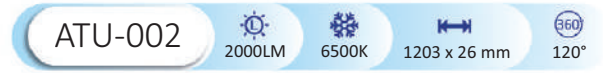
Lámparas LED | TUBOS

ATU-001	Tubo LED T8 Opalino Blanco Frío	90-260V~50/60Hz	Plástico + Vidrio	IP20	Conexión 2 Polos
ATU-002	Tubo LED T8 Transparente Blanco Frío	90-260V~50/60Hz	Plástico + Vidrio	IP20	Conexión 2 Polos
ATU-003	Tubo LED T8 Opalino Blanco Frío	90-260V~50/60Hz	Plástico + Vidrio	IP20	Conexión 2 Polos
ATU-004	Tubo LED T8 con Base Transparente Blanco Frío	90-260V~50/60Hz	Plástico	IP20	Hasta 5 Interconexiones
ATU-005	Tubo LED T8 con Base Opalino Blanco Frío	90-260V~50/60Hz	Plástico	IP20	Hasta 5 Interconexiones
ATU-007	Tubo LED T8 -1 PIN- Transparente Blanco Frío	90-260V~50/60Hz	Plástico + Aluminio	IP20	Conexión 2 Polos
ATU-008	Tubo LED T8 -1 PIN- Opalino Blanco Frío	90-260V~50/60Hz	Plástico + Aluminio	IP20	Conexión 2 Polos

Luminaria LED | **GABINETE**



40W

A Prueba de VAPOR

Gabinete Industrial LED

AGA-006 4000LM 6500K 1170x53x38 mm 120°

Plástico 90-260V~50/60Hz IP65 Exterior



2x G13

A Prueba de VAPOR

Gabinete Industrial para 2 Tubos

AGA-007 IP65 Exterior 1290x95x56 mm 120°

Policarbonato 90-260V~50/60Hz 2x G13



36W

Gabinete LED Slim Sobreponer Tipo Regleta

AGA-008 3600LM 6500K 1200x77x25 mm 120°

Aluminio + PC 90-260V~50/60Hz IP20 Interior

Línea Solar

ACO-008

CABLE 50CM PARA CARGAR LUMINARIA SOLAR

*Solo funciona en ASL-002 y ASL-003



1000LM



*Potencia equivalente de una bombilla incandescente con un valor estimado de 10-12lm/W



Reflector LED SOLAR

Con Panel Externo y Control Remoto

ASL-001

W
*100W

6500K

192x132x41 mm

3.2V 10000mAh LiFePO4 IP65 (Exteriores) Atenuable

Aluminio Gris 90° SMD2835

PANEL: Monocristalino 5V 15Wp MEDIDA PANEL: 350x350x17mm
TIEMPO DE CARGA: 5-6 Horas DÍAS NUBLADOS: 3 Días

2300LM



*Potencia equivalente de una bombilla incandescente con un valor estimado de 10-12lm/W



Reflector LED SOLAR

Con Panel Externo y Control Remoto

ASL-002

W
*200W

6500K

272x199x41 mm

3.2V 20000mAh LiFePO4 IP65 (Exteriores) Atenuable

Aluminio Gris 90° SMD2835

PANEL: Monocristalino 5V 25Wp MEDIDA PANEL: 530x350x17mm
TIEMPO DE CARGA: 5-6 Horas DÍAS NUBLADOS: 3 Días



EN CONDICIONES NORMALES*

- *Potencia equivalente de una bombilla incandescente con un valor estimado de 10-12lm/W
- *Altura máxima recomendada 5m.
- *Incluye accesorio de instalación y control remoto.



3800LM

Luminaria LED **SOLAR**

Con Panel Externo y Control Remoto

ASL-003

W
*300W

 6500K

 532x240x69 mm

 3.2V 40000mAh LiFePO4  IP65 (Exteriores)  Atenuable

 Aluminio Gris  120°x100°  SMD2835

PANEL: Monocristalino 5V 40Wp MEDIDA PANEL: 670x350x25mm
TIEMPO DE CARGA: 5-6 Horas DÍAS NUBLADOS: 3 Días



2500LM

- *Potencia equivalente de una bombilla incandescente con un valor estimado de 10-12lm/W.
- *Altura máxima recomendada 4m.
- *Incluye accesorio de instalación y control remoto.
- *Incluye solo una luminaria por caja.

Luminaria LED **SOLAR**

ALL IN ONE con Panel Integrado y Control Remoto

ASL-004

W
*200W

 6500K

 752x266x45 mm

 3.2V 10000mAh LiFePO4  IP65 (Exteriores)  Atenuable

 Aluminio Gris  90°x130°  SMD2835

PANEL: Monocristalino 6V 30Wp MEDIDA PANEL: 655x260x4mm
TIEMPO DE CARGA: 5-6 Horas DÍAS NUBLADOS: 3 Días



EN CONDICIONES NORMALES*

Línea Solar

1300LM



*Potencia equivalente de una bombilla con un valor estimado de 10-12lm/W
*Altura máxima recomendada 4m.



Luminaria LED SOLAR

ALL IN ONE con Panel Integrado y Control Remoto

ASL-005

*100W



6500K



198x432x63 mm

3.7V 8000mAh LiFePO4 IP65 (Exteriores) Atenuable

Plástico ABS Negro 90° SMD2835

PANEL: Monocristalino 6V 8Wp MEDIDA PANEL: 295x173mm
TIEMPO DE CARGA: 5-6 Horas DÍAS NUBLADOS: 3 Días

500LM



*Potencia equivalente de una bombilla con un valor estimado de 10-12lm/W
*Altura máxima recomendada 2 m.



Reflector LED SOLAR

Con Panel Externo y Control Remoto

ASL-006

*50W



6500K



193x170x46 mm

3.2V 5000mAh LiFePO4 IP65 (Exteriores)

Plástico ABS Negro 90°

Atenuable SMD5050

PANEL: Monocristalino 6V 6Wp
MEDIDA PANEL: 210x200x17mm
TIEMPO DE CARGA: 5-6 Horas
DÍAS NUBLADOS: 3 Días



EN CONDICIONES NORMALES*

Sensor PIR
Activado o con
presencia

600LM



*Potencia equivalente de una bombilla con un valor estimado de 10-12lm/W
*Altura máxima recomendada 2 m.



Luminaria LED SOLAR

ALL IN ONE con Panel Integrado y Control Remoto

ASL-007

*50W



6500K



402x237x43 mm

3.2V 6000mAh LiFePO4 IP65 (Exteriores) Atenuable

Plástico ABS Negro 90° SMD2835

PANEL: Monocristalino 6V 6Wp MEDIDA PANEL: 295x173mm
TIEMPO DE CARGA: 5-6 Horas DÍAS NUBLADOS: 3 Días



5500LM



*Potencia equivalente de una bombilla incandescente con un valor estimado de 10-12lm/W
*Altura máxima recomendada 7m.
*Incluye accesorio de instalación y control remoto.



3500LM



*Potencia equivalente de una bombilla incandescente con un valor estimado de 10-12lm/W
*Altura máxima recomendada 5m.
*Incluye accesorio de instalación y control remoto.

Luminaria LED **SOLAR**

ALL IN ONE Con Panel Externo y Control Remoto

ASL-008

W

*400W



6500K



530x204x68 mm



3.2V 60000mAh LiFePO4



IP65 (Exteriores)



Atenuable



Aluminio Gris



90°



SMD5050

PANEL: Monocristalino 5V 60Wp MEDIDA PANEL: 670x535x25mm
TIEMPO DE CARGA: 5-6 Horas DÍAS NUBLADOS: 3 Días

Luminaria LED Punta Poste **SOLAR**

ALL IN ONE con Panel Integrado y Control Remoto

ASL-009

W

*300W



6500K



550x550x261 mm



3.2V 35000mAh LiFePO4



IP65 (Exteriores)



Atenuable



Plástico ABS Gris



90°



SMD2835

PANEL: Policristalino 6V 40Wp MEDIDA PANEL: 550x550x261mm
TIEMPO DE CARGA: 5-6 Horas DÍAS NUBLADOS: 3 Días



EN CONDICIONES NORMALES*

Reflector LED Cuadrado | SLIM

- Aluminio + Vidrio
- 120° Apertura
- Fácil Instalación



Reflector LED SMD Cuadrado

ARE-013 3300LM 6500K 180X220x45 mm

12-24V== IP66 Exterior

Reflector LED SMD Cuadrado

ARE-014 5500LM 6500K 220X280x50 mm

12-24V== IP66 Exterior



Reflector LED SMD Cuadrado

ARE-001 2200LM 6500K 103X137x23 mm

ARE-002 2200LM 3000K 103X137x23 mm

90-277V~50/60Hz IP66 Exterior



Reflector LED SMD Cuadrado

ARE-003 3300LM 6500K 133X173x31 mm

ARE-004 3300LM 3000K 133X173x31 mm

90-277V~50/60Hz IP66 Exterior



Reflector LED SMD Cuadrado

ARE-005 5500LM 6500K 160X200x32 mm

ARE-006 5500LM 3000K 160X200x32 mm

90-277V~50/60Hz IP66 Exterior

Reflector LED Cuadrado | SLIM

100W

110 LM/W EFICIENCIA



Reflector LED SMD Cuadrado

ARE-007



11000LM



6500K



200x247x33 mm



90-277V~50/60Hz



IP66 Exterior

150W

110 LM/W EFICIENCIA



Reflector LED SMD Cuadrado

ARE-011



16500LM



6500K



230x285x33 mm



90-277V~50/60Hz



IP66 Exterior

200W

110 LM/W EFICIENCIA



Reflector LED SMD Cuadrado

ARE-017



22000LM



6500K



270x330x38 mm



90-277V~50/60Hz



IP66 Exterior

300W

125 LM/W EFICIENCIA



Reflector LED SMD Cuadrado

ARE-025



37500LM



6500K



323x353x45 mm



ALTA POTENCIA



90-277V~50/60Hz



IP66 Exterior

400W

125 LM/W EFICIENCIA



Reflector LED SMD Cuadrado

ARE-026



50000LM



6500K



407x370x45 mm



ALTA POTENCIA



90-277V~50/60Hz



IP66 Exterior

500W

125 LM/W EFICIENCIA



Reflector LED SMD Cuadrado

ARE-027



62500LM



6500K



465x420x48 mm



ALTA POTENCIA



90-277V~50/60Hz



IP66 Exterior

Reflector LED Profesional | SLIM

- Aluminio + Policarbonato
- 90° Apertura
- Fácil Instalación | Con Óptica



MAYOR CALIDAD Y POTENCIA

300W



Reflector LED PROFESIONAL

ARE-018

39000LM

6500K

400 x 49 x 331 mm

ALTA EFICIENCIA



90-277V~50/60Hz



IP66 Exterior

130 LM/W

400W



Reflector LED PROFESIONAL

ARE-022

52000LM

6500K

539 x 395 x 60 mm

ALTA EFICIENCIA



90-277V~50/60Hz



IP66 Exterior

130 LM/W



80W

Luminaria LED WallPack

ARE-021 10000LM 6500K 320x172x130 mm 80x105°

90-277V~50/60Hz IP66 (Exteriores)

Aluminio + PC



30W

Ø 2 Pulgadas TUBO

Luminaria LED DE MURO

ARE-016 3200LM 6500K 125x350x67 mm

100-277V~50/60Hz IP65 (Exteriores)

Aluminio + PCB 90°x130°

Luminaria LED | **CAMPANA**

50W



Campana LED Modular

ARE-015

5000LM 6500K 180x180x125 mm

- 90-260V~50/60Hz
- IP66 Exterior
- Aluminio + PC
- 360° 90°



Para los modelos*
(ARE-008, ARE-009)

INCLUYE
Accesorio para
Fijar en Muro

70W

160
LM/W
EFICIENCIA



Campana LED Industrial

ARE-028

11200LM 6500K D. 195x90 mm

- 90-300V~50/60Hz
- IP66 Exterior
- Aluminio + PC
- 360° 120°

100W

170
LM/W
EFICIENCIA



Campana LED Industrial

ARE-009

17000LM 6500K D.265x119 mm

- 100-277V~50/60Hz
- IP65 Exterior
- Aluminio + PC
- 360° 90°

150W

170
LM/W
EFICIENCIA



Campana LED Industrial

ARE-008

25500LM 6500K D. 290 x 150 mm

- 100-277V~50/60Hz
- IP65 Exterior
- Aluminio + PC
- 360° 90°

Luminaria LED | CAMPANA



200W

170 LM/W EFICIENCIA



240W

170 LM/W EFICIENCIA

Campana LED Industrial

ARE-023 34000LM 6500K D. 346x159 mm

100-277V~50/60Hz IP65 Exterior

Aluminio + PC 90°

Campana LED Industrial

ARE-012 40800LM 6500K D. 396x190 mm

100-277V~50/60Hz IP65 Exterior

Aluminio + PC 60°



Para los modelos* (ARE-023, ARE-012)

INCLUYE
Accesorio para Fijar en Muro



Luminaria LED | PUNTA POSTE

100W



50W/100W



Con BASE para FOTOCELDA de 3 pines



AJUSTE CCT MANUAL



AJUSTE MANUAL

Luminaria LED Punta Poste

Luminaria LED Punta Poste

ARE-024

12000LM 6500K D.466x565mm 150°

Aluminio + Vidrio 90-277V~50/60Hz IP65

ARE-029

Máx.13500LM 3000K/6500K D.458x149 mm 120°

Aluminio + PC 100-277V~50/60Hz IP65

COMPLEMENTOS



IP65

Fotocelda Base NEMA de 3 pines

ACO-010

120-270V~50/60Hz Máx.1000W D. 64 x 82 mm



IP65

Tapa para Base NEMA de 3 pines

ACO-011

90-260V~50/60Hz D. 74 x 25 mm



A Prueba de LLUVIA

IP44



Fotocelda Compacta

ACO-012

90-260V~50/60Hz Máx. 600W 90x35x50 mm



COMPLEMENTOS

Base NEMA para Fococelda de 3 pines

ACO-013

90-260V~50/60Hz

100W

65x100x95 mm

60W

Incluye FOTOCELDA de 3 pines

Ø 2,5 Pulgadas TUBO

Luminaria LED **DE CALLE**

ARE-019

7800LM

6500K

120x456x83 mm

100-277V~50/60Hz IP65 (Exteriores)

Aluminio + PC 70°x130°

100W

Incluye FOTOCELDA de 3 pines

Ø 2,5 Pulgadas TUBO

Luminaria LED **DE CALLE**

ARE-020

13000LM

6500K

527x144x83 mm

100-277V~50/60Hz IP65 (Exteriores)

Aluminio + PC 70°x130°

NUEVO

50W

Con FOTOSENSOR

Ø 2 Pulgadas TUBO

Luminaria LED para Muro y Calle

ARE-030

6000LM

6500K

508x75x107 mm

100-277V~50/60Hz IP65 (Exteriores)

Aluminio + PC 90°x130°

Luminaria LED | JARDÍN

Aluminio + Vidrio

*No Incluye Lámpara

NUEVO



Max. 50W

1x BASE GU10

Luminaria con Base Decorativo de JARDÍN

ADE-301 1x GU10 121x111x92 mm 90°

90-260V~50/60Hz IP65 Exterior



Max. 50W

1x BASE GU10

Luminaria de Estaca para JARDÍN

ADE-302 1x GU10 130x270x100 mm 60°

90-260V~50/60Hz IP65 Exterior



Max. 50W

1x BASE GU10

Luminaria de Estaca para JARDÍN

ADE-310 1x GU10 88x245x75 mm Máx. 60°

90-260V~50/60Hz IP65 Exterior

NUEVO
2025



12W

Max.
50W

1x
BASE
GU10

Luminaria de Estaca para JARDÍN

Luminaria de Estaca para JARDÍN

ADE-311 1x GU10 88x245x75 mm Máx. 60°

ADE-305 1000LM 6500K 95 x 265 x 87 mm 63°

ADE-306 950LM 3000K 95 x 265 x 87 mm 63°

90-260V~50/60Hz IP65 Aluminio + Vidrio

90-260V~50/60Hz IP65 Aluminio + Vidrio



Luminaria LED | PISO



1W

∅ 58mm EMPOTRAMIENTO

Luminaria LED Empotrable de PISO

ADE-203 80LM 6500K D. 64x74 mm 360° 60°

ADE-204 75LM 3000K D. 64x74 mm 360° 60°

Acero Inox. + PP 90-260V~50/60Hz IP67



Max. 50W

1x BASE GU10

∅ 74mm EMPOTRAMIENTO

Luminaria Empotrable de PISO

ADE-201 1x GU10 D. 80x103 mm Max. 90°

Acero Inox. + PP 90-260V~50/60Hz IP67

*No incluye Lámpara



Max. 50W

1x BASE GU10

∅ 100mm EMPOTRAMIENTO

Luminaria Empotrable de PISO

ADE-202 1x GU10 D. 110x110 mm Max. 90°

Acero Inox. + PP 90-260V~50/60Hz IP67

*No incluye Lámpara



1W

∅ 43mm EMPOTRAMIENTO

DOBLE DISPARO

Luminaria LED Empotrable de PISO

ADE-205 80LM 6500K D. 60x54 mm 2x90°

ADE-206 75LM 3000K D. 60x54 mm 2x90°

Aluminio + PC 90-260V~50/60Hz IP67



5W

∅ 73mm EMPOTRAMIENTO

Luminaria LED Empotrable de PISO

ADE-209 260LM 6500K D. 80x74 mm 90°

ADE-210 220LM 3000K D. 80x74 mm 90°

Aluminio + PC 90-260V~50/60Hz IP67



12W

∅ 140mm EMPOTRAMIENTO

Luminaria LED Empotrable de PISO

ADE-207 1000LM 6500K D. 160x89 mm 90°

ADE-208 950LM 3000K D. 160x89 mm 90°

Aluminio + PC 90-260V~50/60Hz IP67

Luminaria LED | MINI POSTE



Máx.
40W

*No incluye
Lampara

1x
BASE
E26/E27

*Luminaria Cilindro MINI POSTE

ADE-309



1x E26/E27



D. 76x520 mm



360°



Acero Inox. + PC.



90-260V~50/60Hz



IP54



10W

Luminaria LED Tipo MINI POSTE

ADE-303



900LM



6500K



160x800x120 mm



120°

ADE-304



850LM



3000K



160x800x120 mm



120°



Aluminio + PC



90-260V~50/60Hz



IP54

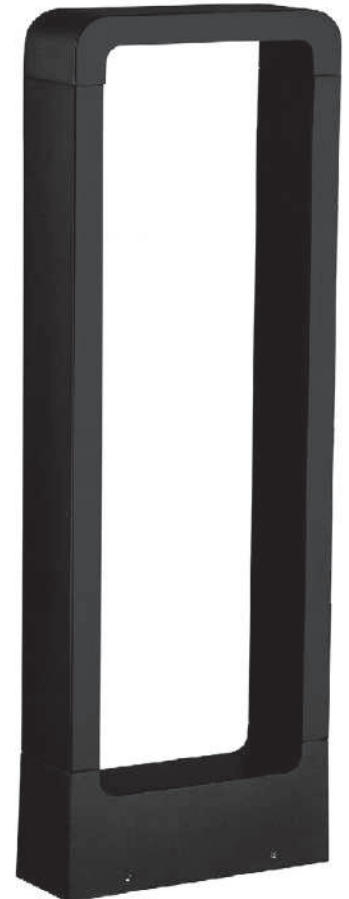

10W

Luminaria LED Tubular MINI POSTE

ADE-307



900LM



6500K



163 x 600 x 57 mm



120°

ADE-308



850LM



3000K



163 x 600 x 57 mm



120°



Aluminio



90-260V~50/60Hz



IP54

Luminaria LED | PARED



1x
BASE
E26/E27

*Luminaria Cilíndrico de PARED

ADE-016 W I

Max. 40W 85 x 255 x 135 mm

- 90-260V~50/60Hz
- IP54 Exterior
- Acero Inox. + PC
- 360°

*No incluye lámpara



10W

Luminaria LED Curvo de PARED

ADE-010 I I I

900LM 6500K 80x240x16 mm

ADE-011 I I I

850LM 3000K 80x240x16 mm

- 90-260V~50/60Hz
- IP54 Exterior
- Aluminio + PC
- 120°

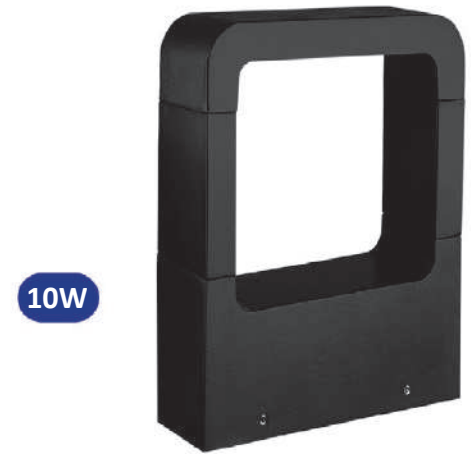

10W

Luminaria LED Tubular de PARED

ADE-014 I I I

900LM 6500K 120 x 160 x 80 mm

ADE-015 I I I

850LM 3000K 120 x 160 x 80 mm

- 90-260V~50/60Hz
- IP54 Exterior
- Aluminio
- 120°

Luminaria LED | CORTESÍA Y PARED

3W



Luminaria LED Decorativo de CORTESIA

ADE-401 240LM 6500K 75 x 81 x 50 mm 360° 45°

ADE-402 200LM 3000K 75 x 81 x 50 mm 360° 45°

Aluminio + Vidrio 90-260V~50/60Hz IP54

6W



Luminaria LED de PARED

ADE-001 500LM 6500K 150 x 100 x 100 mm 360° 120°

ADE-002 450LM 3000K 150 x 100 x 100 mm 360° 120°

Aluminio + Plástico 90-260V~50/60Hz IP54

NUEVO 2025

10W



175x92mm EMPOTRAMIENTO

Decorativo LED Sobreponer de CORTESIA

ADE-403 130LM 6500K 210 x 60 x 65 mm 360° 70°

ADE-404 100LM 3000K 210 x 60 x 65 mm 360° 70°

Aluminio + Vidrio 90-260V~50/60Hz IP65

12W



Luminaria LED de PARED

ADE-007 900LM 6500K 250 x 100 x 100 mm 360° 120°

ADE-008 850LM 3000K 250 x 100 x 100 mm 360° 120°

Aluminio + Plástico 90-260V~50/60Hz IP54

Luminaria LED | **SOBREPONER**

Aluminio + Vidrio + Plástico

90-260V~50/60Hz

IP54 Exterior

*No incluye lámpara



1x
BASE
GU10



*Luminaria Cilindro sencillo de PARED

ADE-003

W

Max. 50W



65 x 75 x 80 mm



Máx.90°



Aluminio + Vidrio + Plástico

2x
BASE
GU10



*Luminaria Cilindro doble de PARED

ADE-004

W

Max. 50W



85 x 255 x 135 mm



Máx.90°



Aluminio + Vidrio + Plástico

1x
BASE
E26/E27



*Luminaria con Rejilla PARED

ADE-005

W

Max. 40W



230 x 260 x 85 mm



Máx.120°



Acero Inox. + Policarbonato

Luminaria LED | PARED

- ✓ IP54 Exterior
- ⚡ 90-260V~50/60Hz
- 🔍 *No incluye lámparas



2x
BASE
GU10

*Luminaria Doble Aro de PARED

ADE-006 W Max. 50W 95 x 225 x 100 mm 360° 90°+90°

Aluminio + Plástico



2x
BASE
GU10

*Luminaria Rectangular de PARED

ADE-012 W Max. 50W 110 x 225 x 110 mm 360° 90°+90°

Aluminio + Plástico



2x
BASE
GU10

*Luminaria Satin Doble de PARED

ADE-013 W Max. 50W 75 x 160 x 105 mm 360° 80°+80°

Aluminio + Vidrio

Luminaria LED | SOBREPONER



90-260V~50/60Hz



IP54 Exterior

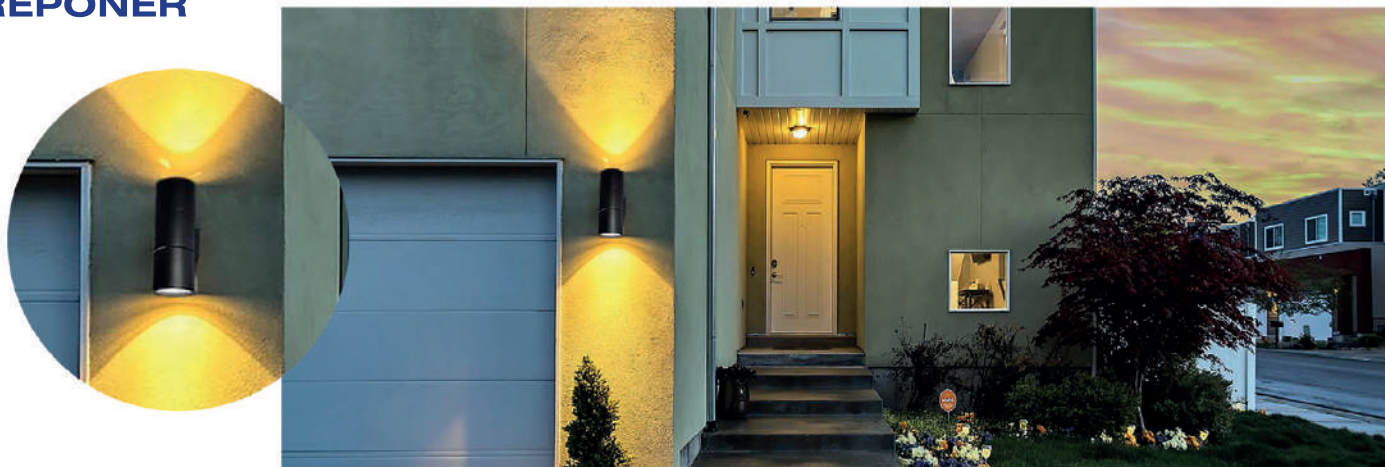

*No incluye lámparas

1x
BASE
E26/E27

Luminaria Cilindro Vertical de PARED

ADE-017

W Max.50W
H 113 x 330 x 135 mm
360°

PC + Aluminio

1x
BASE
E26/E27

Luminaria Rejilla Nautica PARED

ADE-018

W Max.50W
H 105 x 210 x 85 mm
260°

Aluminio + Vidrio

2x
BASE
GU10

Luminaria Cilidro Doble de PARED

ADE-019

W Max.50W
H 64 x 182 x 113 mm
90°x90°

Aluminio + Vidrio

Luminaria LED | PARED

⚡ 90-260V~50/60Hz

✓ IP54 Exterior



6W

90°
ANGULOS AJUSTABLES MANUALES



Cubo Doble Disparo Ajustable de PARED

- ADE-020 360LM 6500K 100 x 100 x 100 mm 2x 0° a 92°
- ADE-021 300LM 3000K 100 x 100 x 100 mm 2x 0° a 92°

Aluminio + Vidrio

11W



Luminaria LED Línea Frontal de PARED

- ADE-022 900LM 6500K 110 x 280 x 136 mm 150x150°
- ADE-023 850LM 3000K 110 x 280 x 136 mm 150x150°

Aluminio + PC

Luminaria LED | PARED

90-260V~50/60Hz

IP54 Exterior

120° Apertura

Disparo Sencillo

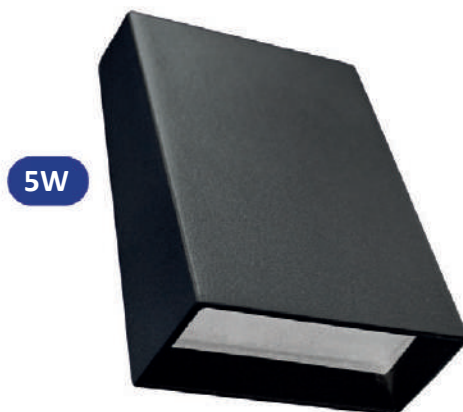

5W

Luminaria Pared Prisma Disparo Sencillo

ADE-024



300LM



6500K



120 x 80 x 40 mm

ADE-025



280LM



3000K



120 x 80 x 40 mm



Aluminio + Vidrio



10W

Luminaria Pared Prisma Disparo Sencillo

ADE-026



600LM



6500K



160 x 100 x 50 mm

ADE-027



550LM



3000K



160 x 100 x 50 mm



Aluminio + Vidrio

18W



Luminaria LED de Pared Barra Lineal

ADE-028



1250LM



6500K



300 x 80 x 50 mm



Aluminio + Vidrio

ADE-029



1200LM



3000K



300 x 80 x 50 mm



Aluminio + Vidrio

NUEVO



10W

90°
ÁNGULOS AJUSTABLES MANUALES



Luminaria Pared Rectangular con Figuras

ADE-030



650LM



6500K



92 x 150 x 50 mm



0° a 90°

ADE-031



600LM



3000K



92 x 150 x 50 mm



0° a 90°



90-260V~50/60Hz



IP54 Exterior



Aluminio + PC



Doble Disparo Ajustable

NUEVO

10W



Luminaria LED Pared Cilindro Cóncavo

ADE-032



360LM



6500K



90 x 200 x 105 mm



77°+77°

ADE-033



360LM



3000K



90 x 200 x 105 mm



77°+77°



90-260V~50/60Hz



IP44 Exterior



Aluminio



Doble Disparo

NUEVO

12W



Luminaria Pared Barra Slim

ADE-034



800LM



6500K



60 x 605 x 105 mm



90°

ADE-035



775LM



3000K



60 x 605 x 105 mm



90°



90-260V~50/60Hz







IP20 Interior



Aluminio + PC

Luminaria LED | **LECTURA**

-  Aluminio + Hierro Galvanizado
-  90-260V~50/60Hz
-  IP20 Interior
-  38° Apertura
-  Rotación Manual Ajustable hasta 360°



NUEVO

Luminaria LED Pared Lectura

ADE-036  146LM  6500K  60 x 140 x 60 mm

ADE-037  140LM  3000K  60 x 140 x 60 mm



2W

USB
2 SALIDAS

 Tipo A  Tipo C

NUEVO





Luminaria LED Pared Lectura con 2 USB

ADE-038  146LM  6500K  60 x 150 x 140 mm

ADE-039  140LM  3000K  60 x 150 x 140 mm

Luminaria LED

PARED

-  Policarbonato
-  90-260V~50/60Hz
-  IP65 Exterior
-  Sobreponer en pared



8W



NUEVO

Luminaria LED Pared Arbotante Cuadrado

ADE-040	 600LM	 6500K	 120 x 120 x 92 mm	 142°
ADE-041	 570LM	 3000K	 120 x 120 x 92 mm	 142°

12W



NUEVO

Luminaria LED Pared Arbotante Circular

ADE-042	 990LM	 6500K	 D. 169 x 100 mm	 128°
ADE-043	 950LM	 3000K	 D. 169 x 100 mm	 128°

Luminaria LED | **TECHO**1x
BASE
GU10

Luminaria Sobreponer Techo Cilindro Dirigible Blanco

ADE-701

W
Máx. 50W

D. 80 x 84 mm

Aluminio

90-260V~50/60Hz IP20 Interior No incluye Lámpara

12x
BASE
E26/E27

Extensión de Sockets para 12 bulbos

ADE-501

W
Máx. 50W

Extensión 7.5 mts

Plástico

90-260V~50/60Hz IP65 Exterior No incluye Lámparas

1x
BASE
GU10

Luminaria Sobreponer Techo Cilindro Dirigible Negro

ADE-702

W
Máx. 50W

D. 80 x 84 mm

Aluminio

90-260V~50/60Hz IP20 Interior No incluye Lámpara

Luminaria LED | **TECHO**



NUEVO
2025

10W



350°
GIRO MANUAL
INCLINACIÓN 45°

Luminaria Sobreponer Techo Cilíndro Dirigible CCT Negro

ADE-703	Máx. 600LM	3000K / 6500K	D. 72 x 98 mm	350° 30°
	90-260V~50/60Hz		IP20 Interiore	



NUEVO
2025

10W

350°
GIRO MANUAL
INCLINACIÓN 45°

Luminaria Sobreponer Techo Aro-Cilíndro Dirigible Negro

ADE-704	800LM	6500K	D. 90 x 88 mm	350° 24°
ADE-705	790LM	3000K	D. 90 x 88 mm	350° 24°
	90-260V~50/60Hz		IP20 Interior	

Luminaria LED | **TECHO**



Aluminio



90-260V~50/60Hz



IP20 Interior

20W

NUEVO
2025



278x36mm
EMPOTRAMIENTO

Luminaria Lineal Empotrable Techo con Óptica

ADE-708

1300LM

6500K

282 x 35 x 45 mm

26°

ADE-709

1300LM

3000K

282 x 35 x 45 mm

26°

NUEVO
2025

10W



145x36mm
EMPOTRAMIENTO

Luminaria Lineal Empotrable Techo con Óptica

ADE-706

650LM

6500K

148 x 45 x 35 mm

26°

ADE-707

650LM

3000K

148 x 45 x 35 mm

26°

20W

NUEVO
2025



Luminaria Lineal Sobreponer Techo con Óptica

ADE-710

1350LM

6500K

268 x 60 x 34 mm

24°

ADE-711

1350LM

3000K

268 x 60 x 34 mm

24°

Empotrables Fijos y Dirigibles

AROS DECORATIVOS



55mm
EMPOTRAMIENTO



Aro Empotrable Fijo

ADE-101

W
Máx.50W

80 x 32 mm

Metal

90-260V~50/60Hz IP20 Interior

*No incluyen lámpara



70mm
EMPOTRAMIENTO



Aro Empotrable Dirigible

ADE-104

W
Máx.50W

89 x 28 mm

Metal

90-260V~50/60Hz IP20 Interior

*No incluyen lámpara



55mm
EMPOTRAMIENTO



Aro Empotrable Fijo

ADE-102

W
Máx.50W

80 x 32 mm

Metal

90-260V~50/60Hz IP20 Interior

*No incluyen lámpara



70mm
EMPOTRAMIENTO



Aro Empotrable Dirigible

ADE-105

W
Máx.50W

89 x 28 mm

Metal

90-260V~50/60Hz IP20 Interior

*No incluyen lámpara



55mm
EMPOTRAMIENTO



Aro Empotrable Fijo

ADE-103

W
Máx.50W

80 x 32 mm

Metal

90-260V~50/60Hz IP20 Interior

*No incluyen lámpara



70mm
EMPOTRAMIENTO



Aro Empotrable Dirigible

ADE-106

W
Máx.50W

89 x 28 mm

Metal

90-260V~50/60Hz IP20 Interior

*No incluyen lámpara

Empotrable Dirigible Cuadrado

AROS CUADRADOS DECORATIVOS

1x
BASE
GU10

 92x92mm
EMPOTRAMIENTO

Empotrable Dirigible Cuadrado Sencillo

ADE-107

W Max.50W
 100x100x40 mm
 Metal

90-260V~50/60Hz
 IP20 Interior

2x
BASE
GU10

 175x92mm
EMPOTRAMIENTO

Empotrable Dirigible Rectangular Doble

ADE-109

W Max.50W
 185x100x40 mm
 Metal

90-260V~50/60Hz
 IP20 Interior

3x
BASE
GU10

 260x92mm
EMPOTRAMIENTO

Empotrable Dirigible Rectangular Triple

ADE-111

W Máx.50W
 270x100x40 mm
 Metal

90-260V~50/60Hz
 IP20 Interior

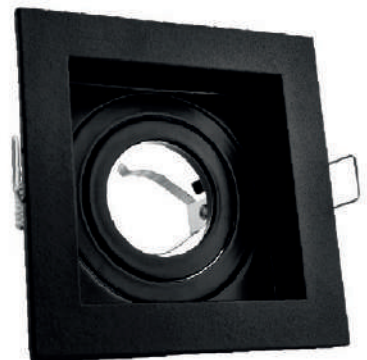
1x
BASE
GU10

 92x92mm
EMPOTRAMIENTO

Empotrable Dirigible Cuadrado Sencillo

ADE-108

W Max.50W
 100x100x40 mm
 Metal

90-260V~50/60Hz
 IP20 Interior

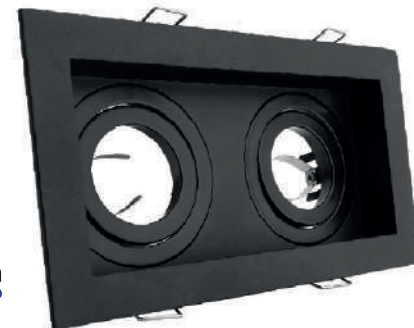
2x
BASE
GU10

 175x92mm
EMPOTRAMIENTO

Empotrable Dirigible Rectangular Doble

ADE-110

W Max.50W
 185x100x40 mm
 Metal

90-260V~50/60Hz
 IP20 Interior

3x
BASE
GU10

 260x92mm
EMPOTRAMIENTO

Empotrable Dirigible Rectangular Triple

ADE-112

W Máx.50W
 270x100x40 mm
 Metal

90-260V~50/60Hz
 IP20 Interior

Luminaria LED

AROS DECORATIVOS PROFESIONALES

1x
BASE
GU10



∅
D. 80mm
EMPOTRAMIENTO

NUEVO
2025

Aro Empotrable Dirigible Circular Blanco

ADE-113

W
Max.40W

↔
D. 92 x 43 mm

◆
Aluminio



90-260V~50/60Hz



IP20 Interior

1x
BASE
GU10



∅
D. 80mm
EMPOTRAMIENTO

NUEVO
2025

Aro Empotrable Dirigible Circular Negro

ADE-114

W
Máx.40W

↔
D. 92 x 43 mmA

◆
luminio



90-260V~50/60Hz



IP20 Interior

1x
BASE
GU10



∅
D. 70mm
EMPOTRAMIENTO

NUEVO
2025

A Prueba de VAPOR

Aro Empotrable Fijo Circular Blanco

ADE-115

W
Max.40W

↔
D. 85 x 54 mm

◆
Aluminio + Metal



90-260V~50/60Hz



IP65 Exterior

1x
BASE
GU10



∅
D. 70mm
EMPOTRAMIENTO

NUEVO
2025

A Prueba de VAPOR

Aro Empotrable Fijo Circular Negro

ADE-116

W
Máx.40W

↔
D. 85 x 54 mm

◆
Aluminio + Metal



90-260V~50/60Hz



IP65 Exterior

Luminaria Decorativa y Complemento

COLGANTES



Complemento Oro Rosado para ADE-601

ACO-005



IP20 Interior



D. 220 x 65 mm



Aluminio

1x
BASE
E26/E27145cm
MEDIDA
de Cable

Colgante Vintage Oro Rosado

ADE-601



Máx.50W



49 x 60 mm



Aluminio+Nílon



90-260V~50/60Hz



IP20 Interior



Complemento Negro Pulido para ADE-602

ACO-006



IP20 Interior



D. 220 x 65 mm



Aluminio

1x
BASE
E26/E27145cm
MEDIDA
de Cable

Colgante Vintage Negro Pulido

ADE-602



Máx.50W



49 x 60 mm



Aluminio+Nílon



90-260V~50/60Hz



IP20 Interior



Complemento Cobre Antiguo para ADE-603

ACO-007



IP20 Interior



D. 220 x 65 mm



Aluminio

1x
BASE
E26/E27145cm
MEDIDA
de Cable

Colgante Vintage Cobre Antiguo

ADE-603



Máx.50W



49 x 60 mm



Aluminio+Nílon



90-260V~50/60Hz



IP20 Interior

Luminaria Decorativa | COLGANTE

1x
BASE
GU10

120cm
MEDIDA
de Cable



Colgante Cilíndrico Blanco

ADE-607

W

Max.50W

↔

170 x 55 mm

◆

Aluminio



90-260V~50/60Hz



IP20 Interior

1x
BASE
GU10

120cm
MEDIDA
de Cable



Colgante Cilíndrico Negro

ADE-608

W

Max.50W

↔

170 x 55 mm

◆

Aluminio



90-260V~50/60Hz



IP20 Interior

1x
BASE
E26/E27

145cm
MEDIDA
de Cable

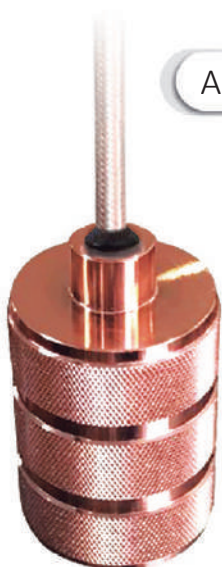

Colgante Cilindro Oro Rosado

ADE-604

W

Max.50W

↔

45 x 64 mm

◆

Aluminio



90-260V~50/60Hz



IP20 Interior

1x
BASE
E26/E27

145cm
MEDIDA
de Cable



Colgante Cilindro Negro Pulido

ADE-605

W

Max.50W

↔

45 x 64 mm

◆

Aluminio



90-260V~50/60Hz



IP20 Interior

1x
BASE
E26/E27

145cm
MEDIDA
de Cable



Colgante Cilindro Cobre Antiquo

ADE-606

W

Max.50W

↔

45 x 64 mm

◆

Aluminio







90-260V~50/60Hz



IP20 Interior

Luminaria LED | COLGANTE









-  Aluminio + Policarbonato
-  90-260V~50/60Hz
-  IP20 Interior
-  Med. Cable 100 cms

 **Con Óptica**

40W











Luminaria LED Colgante con Óptica

ADE-611	 4000LM	 6500K	 1200 x 35 x 62 mm	 36°	 90-260V~50/60Hz
ADE-612	 3600LM	 3000K	 1200 x 35 x 62 mm	 36°	

40W



Luminaria LED Colgante

ADE-609	 4000LM	 6500K	 1200 x 35 x 55 mm	 120°	 90-260V~50/60Hz
ADE-610	 3600LM	 3000K	 1200 x 35 x 55 mm	 120°	

Luminaria LED | COLGANTE

-  Aluminio
-  90-260V~50/60Hz
-  Máx. 60°
-  IP20 Interior
-  Med. Cable 120 cms



NUEVO

1x
BASE
GU10

120 cm
Medida
de Cable



Decorativo Colgante Corte Diagonal 30cm Negro y Oro

ADE-613 **W** Máx.50W **↔** 55 x 300 mm

1x
BASE
GU10

120 cm
Medida
de Cable



Decorativo Colgante Cilindro 60cms Negro y Oro.

ADE-614 **W** Máx.50W **↔** 60 x 600 mm

1x
BASE
GU10

120 cm
Medida
de Cable



Decorativo Colgante Cilindro 60cms Negro y Dorado

ADE-615 **W** Máx.50W **↔** 60 x 600 mm

7W





120 cm
Medida
de Cable



ADE-616  450LM  6500K  40 x 300 mm

ADE-617  450LM  3000K  40 x 300 mm

Luminaria LED | SOBREPONER

-  Metal + Policarbonato
-  90-260V~50/60Hz
-  IP20 Interior
-  120° Apertura
-  Sobreponer / Fácil instalación

6W



12W



18W



Luminaria Sobreponer Techo Circular

WDE-001



360LM



6500K



D. 105 x 40 mm

WDE-002



330LM



3000K



D. 105 x 40 mm

Luminaria Sobreponer Techo Circular

WDE-003



900LM



6500K



D. 138 x 42 mm

WDE-004



850LM



3000K



D. 138 x 42 mm

Luminaria Sobreponer Techo Circular

WDE-005



1440LM



6500K



D. 178 x 44 mm

WDE-006



1400LM



3000K



D. 178 x 44 mm

Luminaria LED | **SOBREPONER**



12W



Luminaria LED Pared Náutica

WDE-007	850LM	6500K	177 x 85 x 55 mm	120°
WDE-008	800LM	3000K	177 x 85 x 55 mm	120°

Plástico
 90-260V~50/60Hz
 IP54 Exterior

18W



Luminaria LED Pared Náutica

WDE-009	1260LM	6500K	200x100x54 mm	120°
WDE-010	1200LM	3000K	200x100x54 mm	120°

Plástico
 90-260V~50/60Hz
 IP54 Exterior

Luminaria LED | **SOBREPONER**



Luminaria LED de CORTESÍA

- WDE-401

88LM
 6500K
 90x120x12 mm
 75°
- WDE-402

64LM
 3000K
 90x120x12 mm
 75°

Policarbonato 90-260V~50/60Hz IP65 Exterior



Luminaria LED de CORTESÍA



- WDE-403

88LM
 6500K
 90x120x12 mm
 75°
- WDE-404

64LM
 3000K
 90x120x12 mm
 75°

Policarbonato 90-260V~50/60Hz IP65 Exterior

Luminaria LED | PARED

-  90-260V~50/60Hz
-  Fácil instalación



NUEVO

2W

90°
ANGULOS AJUSTABLES MANUALES



Luminaria LED Pared Mini Doble Disparo

WDE-011  190LM  6500K  50 x 50 x 40 mm  92°x92°

WDE-012  150LM  3000K  50 x 50 x 40 mm  92°x92°

 Policarbonato  IP65 Exterior

NUEVO

 2x
BASE
GU10



Luminaria Pared Cilindro

WDE-013 **W** Máx.50W  130 x 288 x 100 mm  90°x90°

 ABS + Polipropileno  IP44 Exterior

NUEVO

 2x
BASE
GU10



Luminaria Pared Rectangular

WDE-014 **W** Máx.50W  110 x 230 x 55 mm  90°x90°

 ABS + Polipropileno  IP44 Exterior

Luminaria LED | **EMPOTRABLE**
 90-260V~50/60Hz

 IP20 Interior

 Max. 120°

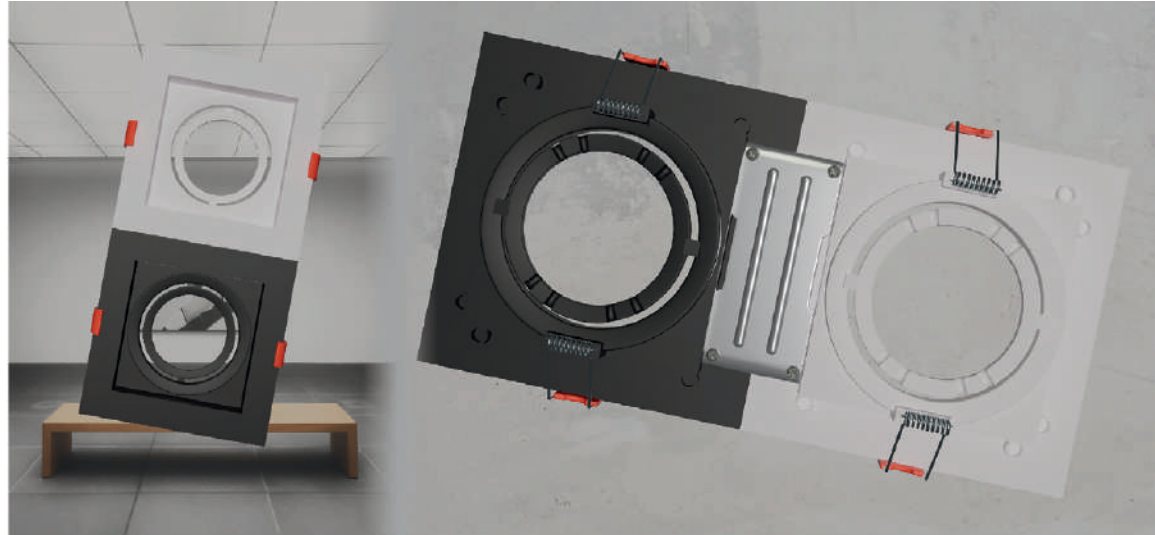
 Emp. 95x95 mm

*Imagen referente a la forma en que se pueden unir uno o más entre sí.

 2x
BASE
GU10

 9.5x9.5cm
EMPOTRAMIENTO

 2x
BASE
GU10

 9.5x9.5cm
EMPOTRAMIENTO
**NUEVO**

Empotrable Dirigible para Spot

WDE-101

 W
Máx.50W

 102 x 102 x 42 mm

 Policarbonato
**NUEVO**

Empotrable Dirigible para Spot

WDE-102

 W
Máx.50W

 102 x 102 x 42 mm

 Policarbonato
**NUEVO**Clip de conexión para Unir
WDE-101 y/o WDE-102

WAC-031

 Incluye tornillos sujetadores

 29x76x6 mm

 Metal

Máx.
50W
2xG13



Gabinete Canaleta Doble T8 120 cm

WGA-001 90-260V~50/60Hz 1217x77x40 mm Metal IP20

Máx.
50W
1xG13



Gabinete Canaleta T8 120 cm

WGA-002 90-260V~50/60Hz 1217x77x40 mm Metal IP20

36W

WGA-003 2880LM 6500K 1200 x 65 x 25 mm 120°

9W

TUBO 60 CMS
TRANSPARENTE



WTU-006 800LM 6500K 600 x 30 mm 120°

18W

TUBO 120 CMS
TRANSPARENTE



WTU-003 1750LM 6500K 1200 x 27 mm 120°

36W

TUBO 240 CMS
TRANSPARENTE



WTU-007 3000LM 6500K 2400 x 30 mm 120°

18W

TUBO 120 CMS
TRANSPARENTE



WTU-005 1600LM 6500K 1200 x 27 mm 120°

TUBO 120 CMS
OPALINO



WTU-004 1700LM 6500K 1200 x 27 mm 150°

TUBO 240 CMS
OPALINO



WTU-008 2800LM 6500K 2400 x 30 mm 150°

NUEVO



WGA-003	Gabinete Slim LED Integrado tipo regleta escolar	90-260V~50/60Hz	Plástico + Aluminio	IP20	Fácil de Instalar
WTU-006	Tubo LED Base Plástico Transparente BF	90-260V~50/60Hz	Plástico + Vidrio	IP20	Con base
WTU-005	Tubo LED Base Plástico Transparente BF	90-260V~50/60Hz	Plástico + Vidrio	IP20	Con base
WTU-003	Tubo LED Vidrio Transparente Blanco Frío	90-260V~50/60Hz	Plástico + Vidrio	IP20	Conexión 2 Polos
WTU-004	Tubo LED Vidrio Opalino Blanco Frío	90-260V~50/60Hz	Plástico + Vidrio	IP20	Conexión 2 Polos
WTU-007	Tubo LED -1 PIN- Transparente Blanco Frío	90-260V~50/60Hz	Plástico + Vidrio	IP20	Conexión 2 Polos
WTU-008	Tubo LED -1 PIN- Opalino Blanco Frío	90-260V~50/60Hz	Plástico + Vidrio	IP20	Conexión 2 Polos

Luminaria LED | PÁNEL

 Policarbonato + Poliestireno

 100-265V~50/60Hz

 IP20 Interior

 120° Apertura

 Fácil instalación

6W



 7.5CM
EMPOTRAMIENTO

Pánel LED Redondo Empotrable

WDO-002



380LM



6500K



D. 101x32 mm

WDO-005



330LM



3000K



D. 101x32 mm

12W



 10.5CM
EMPOTRAMIENTO

Pánel LED Redondo Empotrable

WDO-003



900LM



6500K



D. 132x32 mm

WDO-006



850LM



3000K



D. 132x32 mm

NUEVO

30W



 18.5CM
EMPOTRAMIENTO

Pánel LED Redondo Empotrable

WDO-012



2700LM



6500K



D. 218x33 mm

WDO-013



2600LM



3000K



D. 218x33 mm

 90-260V~50/60Hz

 120° Apertura

 Incluyen driver

36W

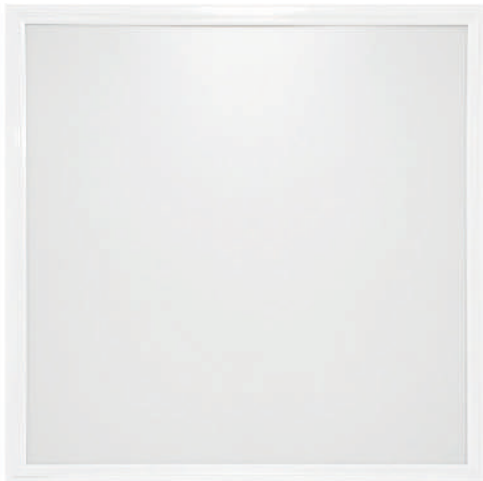

Pánel LED Empotrable Cuadrado



WDO-001  3000LM  6500K  595 x 595 x 30 mm

 Plástico + PC  IP20

72W



Pánel LED Empotrable Rectangular

WDO-004  6000LM  6500K  1195 x 595 x 30 mm

 Plástico + PC  IP20

NUEVO

8W

AJUSTABLE



 MIN. 5 CM
MAX. 11 CM
EMPOTRAMIENTO



Pánel Redondo Empotrable Ajustable

WDO-008  330LM  6500K  D. 118x25 mm

WDO-009  300LM  3000K  D. 118x25 mm

 Aluminio + PC + Vidrio  IP22

20W

NUEVO

AJUSTABLE

 MIN. 5 CM
MAX. 20.5 CM
EMPOTRAMIENTO



Pánel Redondo Empotrable Ajustable

WDO-010  1440LM  6500K  D. 228 x 25 mm

WDO-011  1400LM  3000K  D. 228 x 25 mm

 Aluminio + PC + Vidrio  IP22

Lámparas LED | SPOT Y BULBO



3W

Lámpara LED Spot Multicolor E26

WLA-005 Max.200LM RGB D. 50 x 65 mm 30°

90-260V~50/60Hz Aluminio IP20



7W

Lámpara LED Spot MR16

WLA-012 595LM 6500K D. 50 x 53 mm 40°

WLA-013 560LM 3000K D. 50 x 53 mm 40°

100-140V~50/60Hz Plástico IP20



NUEVO

7W

Lámpara LED Spot GU10

WLA-016 595LM 6500K D. 50 x 53 mm 40°

WLA-017 560LM 3000K D. 50 x 53 mm 40°

100-140V~50/60Hz Plástico IP20



3W

Lámpara LED Bulbo E26

WLA-006 250LM 6500K D. 45 x 80 mm 220°

WLA-007 230LM 3000K D. 45 x 80 mm 220°

100-140V~50/60Hz Plástico + PC IP20



5W

Lámpara LED Bulbo E26

WLA-001 430LM 6500K D. 55 x 98 mm 220°

WLA-008 400LM 3000K D. 55 x 98 mm 220°

100-140V~50/60Hz Plástico + PC IP20



10W

Lámpara LED Bulbo E26

WLA-002 850LM 6500K D. 60 x 105 mm 220°

WLA-009 800LM 3000K D. 60 x 105 mm 220°

100-140V~50/60Hz Plástico + PC IP20

Lámparas LED | BULBO



10W
c/u



3 PACK
Incluye 3 lámparas*

3 Pack Lámpara LED E26

Plástico + PC

100-140V~50/60Hz

IP20 Interior

WLA-014

850LM

6500K

D. 60 x 105 mm

220°

WLA-015

800LM

3000K

D. 60 x 105 mm

220°

20W



Lámpara Industrial E26 BULBO

WLA-010

1700LM

6500K

D. 60 x 105 mm

150°

Plástico + PC

90-260V~50/60Hz

IP20

50W



Lámpara Industrial E26 BULBO

WLA-011

4500LM

6500K

D.140 x 207 mm

150°

Plástico + PC

90-260V~50/60Hz

IP20

Reflector Slim LED | REFLECTORES

10W



Luminaria LED REFLECTOR



WRE-004 700LM RGB 115 x 99 mm 120°
90-277 V~50/60Hz IP65 Exterior

50W



Luminaria LED REFLECTOR



WRE-006 3000LM RGB 205 x 182 x 31 mm 120°
90-277V~50/60Hz IP65 Exterior

100W



Luminaria LED REFLECTOR



WRE-015 6000LM RGB 260 x 185 x 30 mm 120°
90-277V~50/60Hz IP65 Exterior

10W



REFLECTOR LED Portatil USB

WRE-011 800LM 6500K 150x90x25 mm
100-277V~50/60Hz IP54 Exterior

10W



100 LM/W EFICIENCIA

Luminaria LED REFLECTOR

WRE-008 1000LM 6500K 100x98x26 mm
100-277V~50/60Hz IP65 Exterior

20W



100 LM/W EFICIENCIA

Luminaria LED REFLECTOR

WRE-009 1900LM 6500K 120x112x28 mm
100-277V~50/60Hz IP65 Exterior



Reflector Slim LED | REFLECTORES

-  Aluminio + Vidrio
-  360°
-  Fácil Instalación.



Luminaria LED **REFLECTOR**



WRE-012  3000LM  6500K  155x140x30 mm

 100-277V~50/60Hz  IP65 Exterior



Luminaria LED **REFLECTOR**

WRE-013  5000LM  6500K  190x170x32 mm



 100-277V~50/60Hz  IP65 Exterior

NUEVO



Luminaria LED **REFLECTOR**



WRE-014  10000LM  6500K  240x210x34 mm

 100-277V~50/60Hz  IP65 Exterior



Luminaria LED **REFLECTOR**

WRE-016  20000LM  6500K  330x275x38 mm

 100-277V~50/60Hz  IP65 Exterior





Aluminio + Policarbonato



100-277V~50/60Hz



IP65 Exterior



120° Apertura



Incluye aro para colgar.

Cable de conexión 30cm de longitud.

100W



Campana LED Industrial

WRE-007



13000LM



6500K



D. 259 x 42 mm

200W



Campana LED Industrial

WRE-010



26000LM



6500K



D. 330 x 42 mm

300W



Campana LED Industrial

WRE-017



36000LM



6500K



D. 360 x 42 mm

NUEVO

MANGUERA RGB

NUEVO
2025



CONTROL Y
CONTROLADOR

WAC-201

110V-220V

90 x 70 x 28 mm

*Compatible con WMA-001

100W

ATENUABLE



MANGUERA RGB 25 mts Exterior



WMA-001

Máx.1800LM

RGB

25000 x 16 x 5 mm

120°

PCB + PVC

IP65 Exterior

127V



CONECTOR MEDIO
Para Manguera RGB.

WAC-202

110V-220V

90 x 70 x 28 mm

*Compatible con WMA-001

Luminaria

MANGUERA LED

Silicón



127V~50/60Hz



IP65 Exterior



120°

Se puede cortar cada 1mt.
(Doble LED cada 50cm.)**MANGUERA DOBLE LED**

25 mts Exterior

150W
120LEDS/M

WMA-008 3500LM AZUL 25000 x 13 x 6 mm

WMA-009 4600LM ROJO 25000 x 13 x 6 mm

WMA-010 7000LM VERDE 25000 x 13 x 6 mm

WMA-011 7000LM AMARILLO 25000 x 13 x 6 mm

**40W**

- ATENUABLE +

60LEDS/M

MANGUERA LED 10 mts Exterior

WMA-012 2800LM 6500K 10000 x 11 x 7 mm

WMA-013 2720LM 3000K 10000 x 11 x 7 mm

100W

- ATENUABLE +

60LEDS/M

MANGUERA LED 25 mts Exterior

WMA-006 7000LM 6500K 25000 x 13 x 6 mm

WMA-007 6800LM 3000K 25000 x 13 x 6 mm

150W

- ATENUABLE +

120LEDS/M

MANGUERA DOBLE LED
25 mts Exterior

WMA-014 10500LM 6500K 25000 x 13 x 6 mm

WMA-015 10400LM 3000K 25000 x 13 x 6 mm

Conectores | ACCESORIOS

Máx.
200W



Conector Simple Kit Manguera de 50m

WAC-012 Para Manguera de 127V. 470 x 33 mm

- Plástico
- 127V~50/60Hz
- IP65

Máx.
500W



Atenuador RF Manguera LED con Control

WAC-016 Med. cable: 16.6/25.5 cm 95 x 25 x 67 mm

- Plástico
- 127V~50/60Hz
- IP20

Máx.
100W



Conector Extensión Manguera 2835

WAC-013 Incluye 2 Pines 250 x 19 mm

- Plástico
- 127V~50/60Hz
- IP65

Máx.
100W



Conector Medio para Manguera.

WAC-017 Incluye 2 Pines 16 x 59 x 10 mm

- Plástico
- 127V~50/60Hz
- IP65

MANGUERA NEÓN



Silicón



127V~50/60Hz



IP65 Exterior



150°



Corte cada 1mt.

Requiere atenuador compatible

150W



MANGUERA NEÓN 25 mts Exterior

WMA-016



10500LM



6500K



25000 x 10 x 15 mm

WMA-017



10000LM



3000K



25000 x 10 x 15 mm

WMA-018



5250LM



VERDE



25000 x 10 x 15 mm

WMA-019



5250LM



AZUL



25000 x 10 x 15 mm

WMA-020



1000LM



ROJO



25000 x 10 x 15 mm

Máx.

300W



Conector Simple Manguera NEÓN

WAC-018



Incluye 1 Pin



500 x 33 mm



Plástico



127V~50/60Hz



IP65

Máx.

150W



Conector Extensión Manguera NEÓN

WAC-032



Incluye 2 Pines



250 x 19 mm



Plástico



127V~50/60Hz



IP65

Máx.

150W



Conector Medio Manguera NEÓN

WAC-033



Incluye 2 Pines



65 x 16 x 10 mm



Plástico



127V~50/60Hz



IP65

0.72W



MÓDULO 3 LEDs SMD RGB

WMO-001 15-40LM RGB 75 x 15 x 5 mm 120°

12V = IP65 Exterior

1.2W



MÓDULO 3 LEDs SMD 2835

WMO-008 100LM 6500K 75 x 15 x 5 mm 120°

WMO-009 95LM 3000K 75 x 15 x 5 mm 120°

12V = IP65 Exterior

0.72W



MÓDULO 3 LEDs SMD 2835

WMO-010 15LM AZUL 75 x 15 x 5 mm 120°

WMO-011 20LM ROJO 75 x 15 x 5 mm 120°

WMO-012 30LM VERDE 75 x 15 x 5 mm 120°

WMO-013 30LM AMARILLO 75 x 15 x 5 mm 120°

12V = IP65 Exterior

1.4W



MÓDULO Super LED con Optica

WMO-014 130LM 6500K 70 x 35 x 20 mm 150°

WMO-015 25LM AZUL 70 x 35 x 20 mm 150°

WMO-016 30LM ROJO 70 x 35 x 20 mm 150°

12V = IP65 Exterior

1W



MÓDULO 2 LED's Samsung

WMO-017 100LM 6500K 16 x 41 mm 150°

WMO-018 100LM 4000K 16 x 41 mm 150°

WMO-019 100LM 3000K 16 x 41 mm 150°

12V = IP67 Exterior

1.6W



MÓDULO LED 3xSMD 2835

WMO-020 115LM 6500K 87 x 19 x 9 mm 120°

WMO-021 115LM 3000K 87 x 19 x 9 mm 120°

100-135V~50/60Hz IP67 Exterior

Se instalan en grupos de 2 módulos

NUEVO

1.4W



12V =

IP54 Exterior

MÓDULO LED Tipo Abanico

WMO-022 110LM 6500K 47 x 23 x 16 mm 10°x 170°

WMO-023 110LM 3000K 47 x 23 x 16 mm 10°x 170°



Luminaria LED | TIRA



12V ==



120°



*Requiere atenuador externo.
Se vende por separado (WAC-001)
solo para la tira WTI-001 / WTI-002.
Corte cada 5cm (3 LEDs).

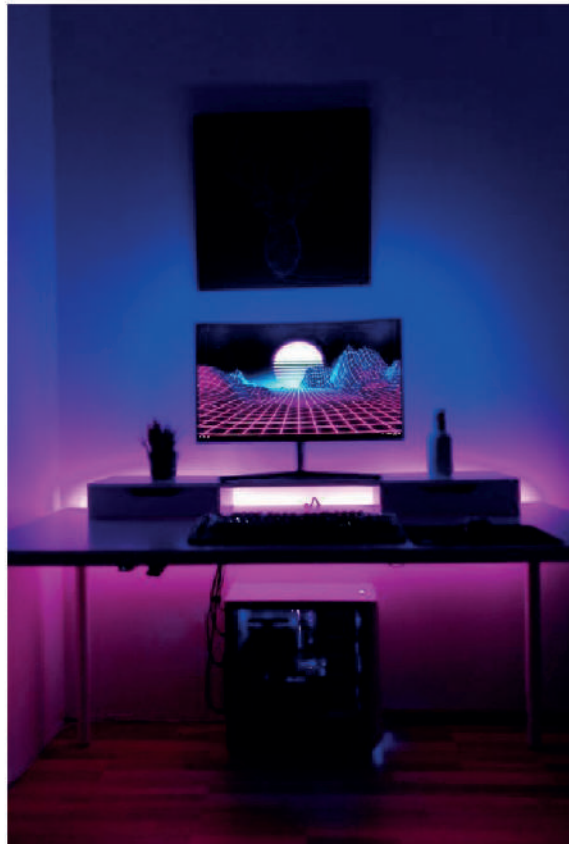

36W



300 LED Exterior 5050



WTI-001 Máx.1800LM RGB 5000 x 10 x 2 mm



Cubierta Silicón



IP65 Exterior

72W



300 LED Exterior 5050



WTI-002 Máx. 3500LM RGB 5000x10x2 mm



Cubierta Silicón



IP65 Exterior

72W



300 LED Exterior 5050

WTI-003 3600LM 6500K 5000 x 10 x 2 mm

WTI-004 3400LM 3000K 5000 x 10 x 2 mm



Cubierta Silicón



IP65 Exterior

24W



300 LED Interior 2835



WTI-005 1300LM 6500K 5000 x 10 x 2 mm



Flexible Adhesivo



IP20 Interior

-  12V \equiv
-  120°
-  Atenuable



24W

TIRA LED Exterior 2835



- WTI-006  1300LM  6500K  5000 x 10 x 2 mm
- WTI-007  1250LM  3000K  5000 x 10 x 2 mm

-  Cubierta Silicón
-  IP65 Exterior



*Corte cada 3 leds



24W

TIRA LED Exterior 2835



- WTI-008  280LM  AZUL  5000 x 10 x 2 mm

-  Cubierta Silicón
-  IP65 Exterior

*Corte cada 3 leds



72W

TIRA LED Interior 5050



- WTI-012  3600LM  6500K  5000 x 10 x 2 mm

-  Flexible Adhesivo
-  IP20 Interior

*Corte cada 3 leds



2W

TIRA LED Arroz Exterior



- WTI-017  130LM  6500K  10000 x 3 mm
- WTI-016  130LM  3000K  10000 x 3 mm



-  Cobre + Silicón
-  IP65 Exterior

Kit de instalación | **PERFILES DE ALUMINIO**

WPE-001

PROXIMAMENTE
NUEVO CÓDIGO



WAC-020

 Lámina + Plástico
 17 x 14 mm

WPE-002

PROXIMAMENTE
NUEVO CÓDIGO



WAC-025

 Lámina + Plástico
 24 x 7 mm

WPE-003

PROXIMAMENTE
NUEVO CÓDIGO

WAC-027

 Lámina + Plástico
 16 x 10 mm

WPE-101

PROXIMAMENTE
NUEVO CÓDIGO

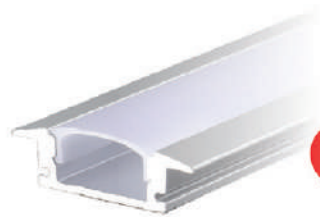

WAC-019

 Aluminio + PC
 2000 x 14 x 16.8 mm

WPE-102

PROXIMAMENTE
NUEVO CÓDIGO

WAC-024

 Aluminio + PC
 2000 x 24 x 7 mm

WPE-103

PROXIMAMENTE
NUEVO CÓDIGO

WAC-026

 Aluminio + PC
 2000 x 16 x 10.5 mm

**DISCRETO
SIN BORDES**

**CON BORDES
ALUMINIO
VISIBLES**

**90°
IDEAL PARA
ESQUINAS**

**NUEVO
2025**



WPE-004
PROXIMAMENTE
NUEVO CÓDIGO

WAC-029 Lámina + Plástico 18 x 6 mm



WPE-005 Aluminio + PC 28 x 11 mm



WPE-104
PROXIMAMENTE
NUEVO CÓDIGO

WAC-028 Aluminio + PC 2000 x 18 x 6 mm



WPE-105 Aluminio + PC 2000 x 28 x 11 mm

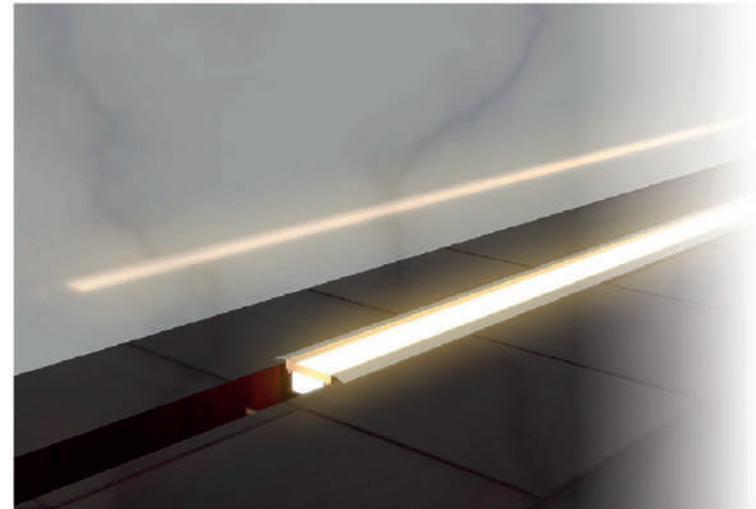

360°

120°



Requiere atenuador compatible.
Corte cada 5cm.

TIRA LED COB Continuo 5M

WTI-013	6000LM	3000K	5000 x 10 x 2 mm
WTI-014	6000LM	4000K	5000 x 10 x 2 mm
WTI-015	6000LM	6500K	5000 x 10 x 2 mm

Tira Flexibe Adhesiva IP20 Interior

72W

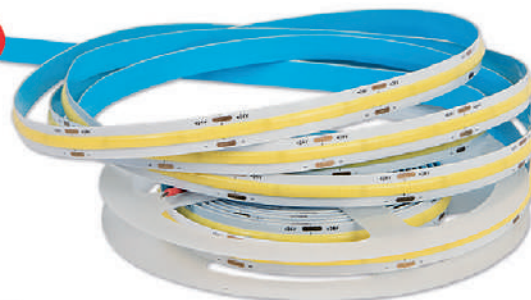

ATENUABLE

24V

TIRA LED COB Continuo 5M

WTI-018	4000LM	6500K	5000 x 8 x 2 mm
WTI-019	4000LM	3000K	5000 x 8 x 2 mm

Tira Flexibe Adhesiva IP20 Interior

55W 12V

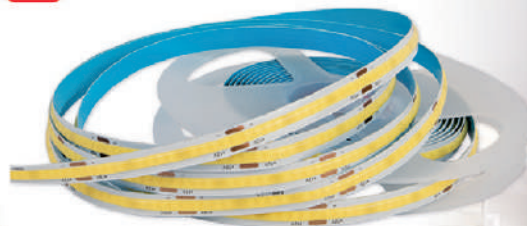

ATENUABLE

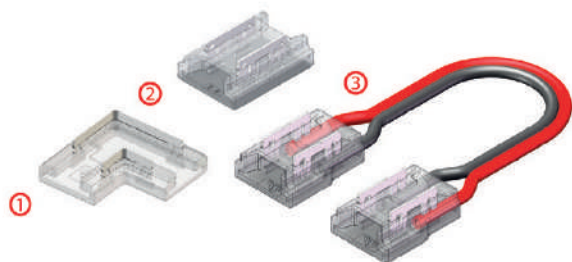

Interconector para Unir Tiras COB 10mm

WAC-103 Union para tira COB Plástico + Aleación de cobre

1 18,6 x 18,6 x 3,5 mm 2 13,5 x 11,5 x 4,2 mm 3 163,5 x 11,5 x 4,2 mm

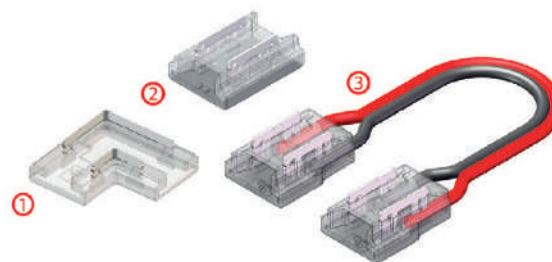

Interconector para Unir Tiras COB 8mm

WAC-104 Union para tira COB Plástico + Aleación de cobre

1 17 x 17 x 3,5 mm 2 13,5 x 8,6 x 4,2 mm 3 13,5 x 11,5 x 4,2 mm

TIRA LED COB Continuo 5M

55W 12V

WTI-020 4000LM 6500K 5000 x 10 x 4 mm

WTI-021 4000LM 3000K 5000 x 10 x 4 mm

Cubierta Silicón IP67 Exterior ATENUABLE



110W 24V

NUEVO
2025

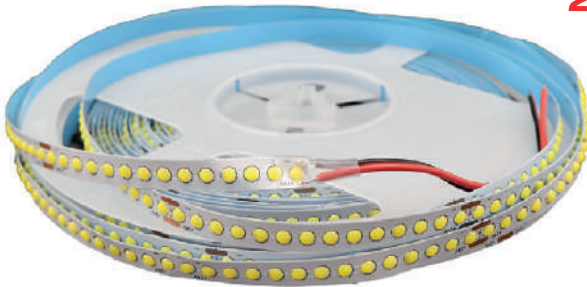

TIRA LED DOT COB 10M ATENUABLE

WTI-102 1000LM 6500K 10000 x 8 x 2 mm 120°

WTI-103 950LM 4000K 10000 x 8 x 2 mm 120°



WTI-104 900LM 3000K 10000 x 8 x 2 mm 120°

PCB Flexible IP20 Interior 24V

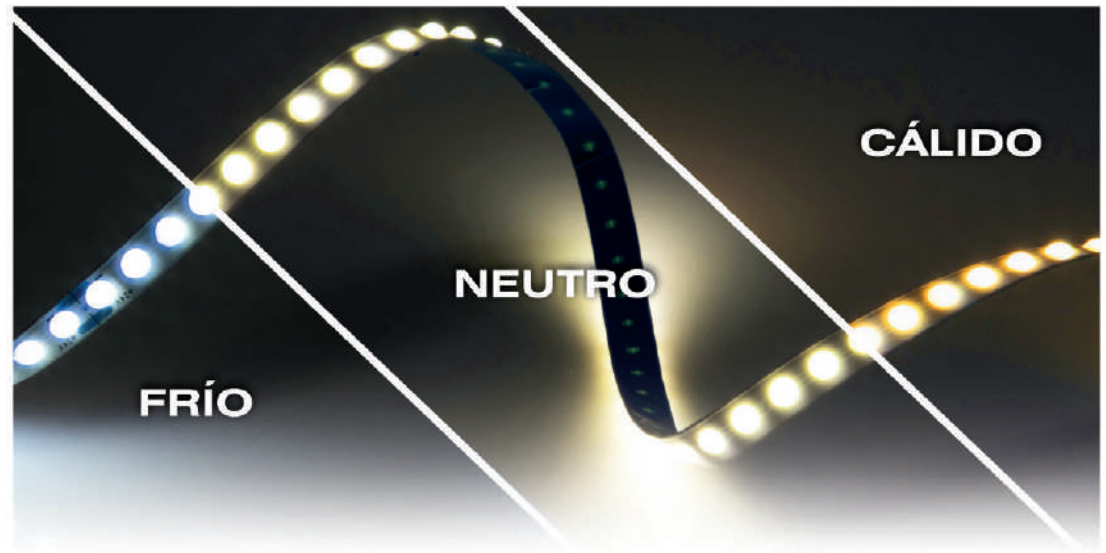
*Corte cada 7,7cms (14 leds)



LED DOT

-  Silicón
-  150°
-  Requiere atenuador compatible
Corte cada 2.5cm

 12V

 ATENUABLE

Tira Flexible LED **NEÓN**

WTI-022

 1250LM

 6500K

 5000 x 6 x 12 mm

 12V ==

 IP65 Exterior

48W



*Ideal para letreros NEÓN



48W

 ATENUABLE

 12V

Tira Flexible LED **NEÓN**

WTI-023

 1000LM

 ROSA

 5000 x 6 x 12 mm

 12V ==

 IP65 Exterior

TIRA LED DIGITAL Caminata

 Tira Flexible Adhesiva

 150°

 Requiere Controlador WAC-023.
Corte cada 8.6cm

60W

EFEECTO Caminata



TIRA LED COB Digital Continuo

WTI-024  4000LM  6500K  5000 x 3 x 10 mm

WTI-025  4000LM  3000K  5000 x 3 x 10 mm

 24V

 IP20 Interior

 ATENUABLE



EFEECTO Caminata



CONTROLADOR Y CONTROL

28 programas preestablecidos

WAC-023  24V  155x13x10 mm

*Compatible con WTI-024 y WTI-025

TIRA LED PIXEL



Requiere controlador WAC-030
Corte cada 5cm (3 LEDs)

72W

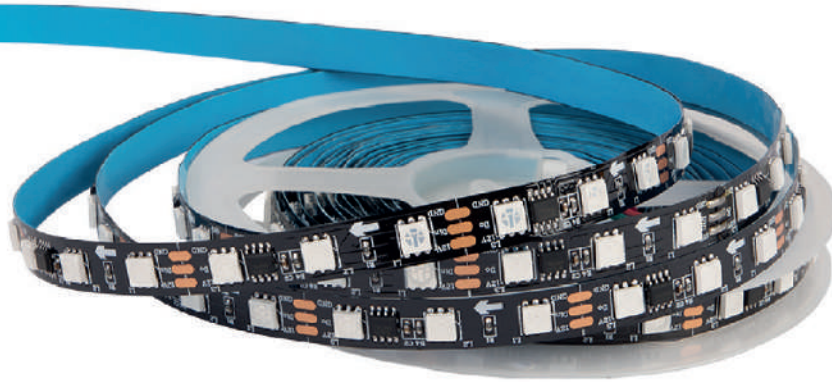

TIRA LED PIXEL RGB Multicolor



WTI-026



3500LM



RGB



5000 x 6 x 12 mm



120°



PCB Negro



IP20 Interior



12V ===



ATENUABLE

12V

Iluminación
RGB

CONTROLADOR Y CONTROL

Con más de 200 programas preestablecidos

WAC-030



5V-12V ===



250x13x11 mm

*Compatible con WTI-026

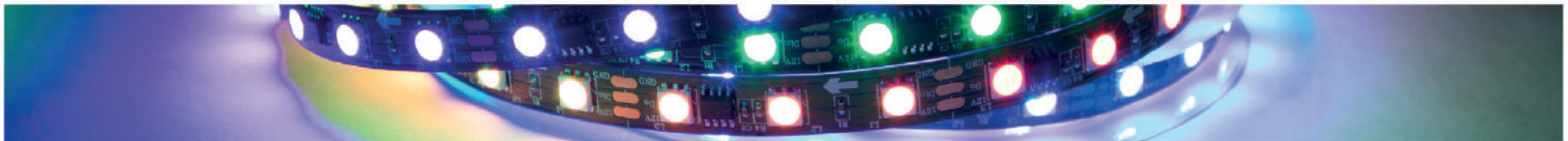

TIRA COB PIXEL DIGITAL

 Requiere controlador WAC-101
Corte cada 10cm.





60W



NUEVO
2025



TIRA COB PIXEL DIGITAL



WTI-101  Máx.3000LM  RGB  5000 x 10 x 2 mm  120°

 Flexible Adhesivo  IP20 Interior  24V \equiv

CONECTA VIA



24V



Iluminación
RGB

CONTROLADOR Y CONTROL

Con más de 200 programas preestablecidos

WAC-101  12V-24V \equiv  60x32x16 mm

*Compatible con WTI-101 y WTI-026

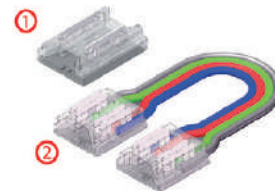

WAC-102  Unión para tira  Plástico + Aleación de cobre

 ① 13,5 x 11,5 x 4,2 mm ② 163,5 x 11,5 x 4,2 mm

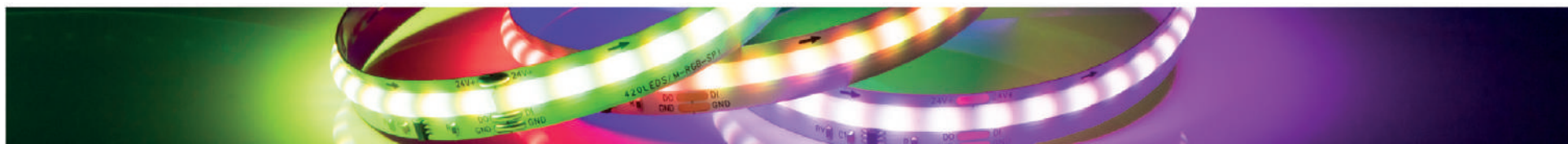

Eliminador de Voltaje | **ELIMINADORES Y FUENTES DE PODER****24W** **12V****110cm**
MEDIDA
de Cable

Eliminador de Voltaje CD 12V a 2A

WEL-001

Eficiencia 80%

82 x 45 x 30 mm



90-260V~50/60Hz



12V =



IP20 Interior

60W **12V****110 cm**
MEDIDA
de Cable C/U

Eliminador de Voltaje CD 12V a 5 A

WEL-002

Eficiencia 80%

120 x 60 x 40 mm



90-260V~50/60Hz



12V =

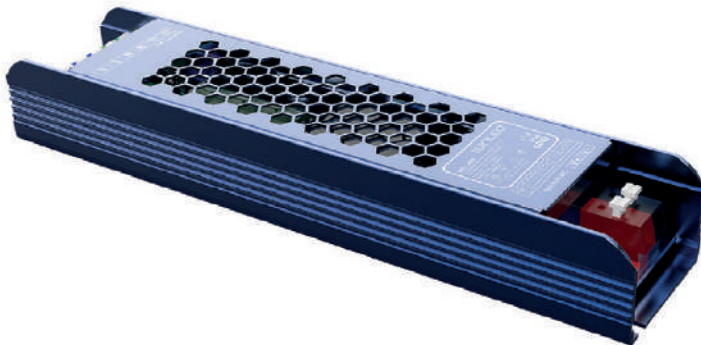

IP20 Interior

60W **12V**

Fuente de Poder CD 12V a 5A Aluminio

WEL-005

Eficiencia 90%

170 x 25 x 23 mm



90-260V~50/60Hz



12V =

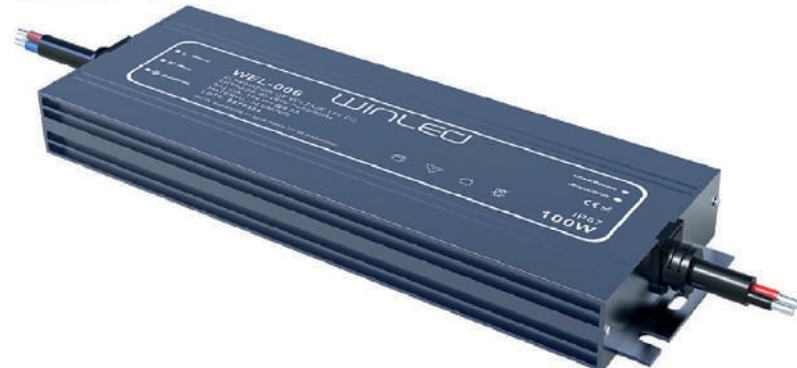

IP20 Interior

100W **12V**

Fuente de Poder CD 12V a 8.5A Aluminio Resistente

WEL-006

Eficiencia 90%

183 x 64 x 19 mm



90-260V~50/60Hz



12V =



IP67 Exterior

Eliminador de Voltaje

ELIMINADORES Y FUENTES DE PODER

200W ⚡ **12V**



Fuente de Poder CD 12V a 16.7A
Aluminio Impermeable

WEL-007 Aluminio Imp. Eficiencia 90% 181 x 103 x 50 mm

100-140V~50/60Hz 12V= IP63 Interior

350W ⚡ **12V**



Fuente de Poder CD 12V a 29.17A
Aluminio Impermeable

WEL-008 Aluminio Imp. Eficiencia 90% 181 x 103 x 50 mm

100-140V~50/60Hz 12V= IP63 Interior

150W ⚡ **12V**

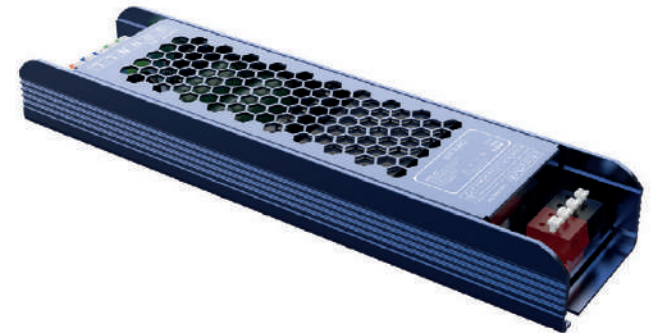

Fuente de Poder CD 12V a 12.5A

WEL-012 Aluminio Eficiencia 90% 195 x 24 x 48 mm

90-260V~50/60Hz 12V= IP20 Interior

100W ⚡ **24V**



Fuente de Poder CD 24V a 4.17A

WEL-011 Aluminio Eficiencia 90% 145 x 48 x 30 mm

90-260V~50/60Hz 24V= IP20 Interior

300W ⚡ **24V**

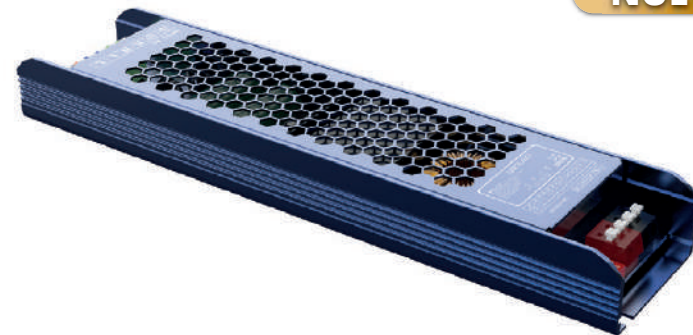

Fuente de Poder CD 24V a 12.5A

WEL-013 Aluminio Resistente Eficiencia 90% 236 x 49 x 29 mm

90-260V~50/60Hz 24V= IP20 Interior

NUEVO

Conectores | ACCESORIOS

72W

Largo del cable: 7cm

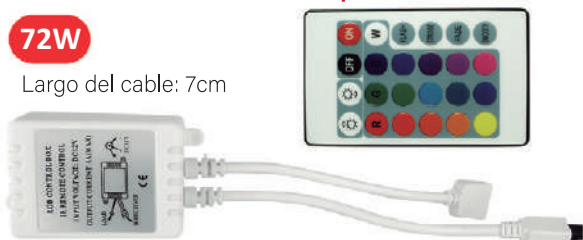

Controlador Tira RGB Control de 16 Colores

WAC-001

 Incluye Control con batería
50 x 35 x 22 mm

Plástico 12V IP20 Interior

72W



Amplificador Tira RGB Slim Interior

WAC-002

 Amplificador
162 x 13 mm

Plástico 12V IP20 Interior

100W



Conector Base G13 para tubo T8

WAC-007

 Para tubo T8
38 x 38 mm

Plástico 90-260V~50/60Hz IP20

100W



Conector base MR16 Plástico con cable

WAC-005

 Med. cable: 10.3cm
17 x 10 mm

Plástico 90-260V~50/60Hz IP20

100W



Conector base GU10 Cerámica con cable

WAC-006

 Med. cable: 7.2 cm
28 x 16 mm

Cerámica 90-260V~50/60Hz IP20

100W



Kit de conexión de Tubo LED

WAC-014

 Para Tubo G13
170 x 21 x 14 mm

Plástico 90-260V~50/60Hz IP20

Max.
50W

Conector G9

WAC-021

 Cable 8 cm
100 x 20 x 30 mm

Plástico 90-260V~50/60Hz IP20 Interior

Max.
50W

Contratuera Base E26

WAC-022

 Base E26
54 x 52 mm

Plástico 90-260V~50/60Hz IP20 Interior

Clip para Fijación de Manguera

WAC-015

 Kit de 25 piezas
35 x 10 x 7 mm



Plástico IP65 Exterior

Adaptadores | ACCESORIOS

Max.
50W



Adaptador de Base E26 a Lámpara E12

WAD-001  E26 a E12  29 x 26 mm

 Lamina +Plástico  90-300V~50/60Hz  IP20

Max.
50W



Adaptador de Base E26 a Lámpara GU10



WAD-002  E26 a GU10  35 x 50 mm

 Lamina +Cerámica  90-300V~50/60Hz  IP20

Max.
50W



Adaptador de Base E40 a Lámpara E26

WAD-003  E40 a E26  45 x 50 mm

 Lamina +Plástico  90-300V~50/60Hz  IP20

Max.
50W



Adaptador GU10 a Lámpara MR16



WAD-004  GU10 a MR16  23 x 21 mm

 Lamina +Cerámica  90-300V~50/60Hz  IP20

Max.
50W



Extensión Flexible 30 cm E26 a E26



WAD-005  Ext. 30cm / E26 a E26  306 x 36 mm

 Lamina +Plástico  90-300V~50/60Hz  IP20

Max.
50W



Adaptador Base E14 a Lámpara E12

WAD-006  Base E14 a E12  54 x 52 mm

 Lamina +Plástico  90-300V~50/60Hz  IP20



NOM-058-SCFI-2017
NOM-003-SCFI-2014
NOM-030-ENER-2016
NOM-031-ENER-2019



WINLED
Más que iluminación



www.innlite.com



ar7lite
ILUMINACIÓN LED

Grupo INNLITE, te informa que nuestros productos se encuentran certificados bajo la **NORMA OFICIAL MEXICANA**. Cada familia de producto, requiere una o varias NOM en específico, la cual **Grupo INNLITE**, puede brindarte a solicitud expresa. ¿Por qué comprar productos certificados? El certificado de cada producto, garantiza que nuestros productos cumplen con los criterios de Calidad, Seguridad, Eficiencia y Correcto Funcionamiento, que demanda el gobierno federal, a través de sus dependencias competentes. Cuando utilizas Producto **AR7LITE** o **WINLED**, estas garantizando la satisfacción de tu cliente o proyecto.